

Features

- 33-inch minimum base cabinet width.
- KOHLER cast iron.
- Acid-resistant enamel finish.
- Top-mount.
- Single compartment.
- Three faucet holes with one accessory hole to the right.
- 33" (838 mm) x 22" (559 mm).

Recommended Accessories

K- 9000 P-Trap

Optional Accessories

K- 6063 Sink Rack
K- 6637 Cutting Board
K- 8801 Sink Strainer



Codes/Standards











ASME A112.19.1/CSA B45.2

KOHLER® Enameled Cast Iron Kitchen Sink - Lifetime Limited Warranty

See website for detailed warranty information.

Available Color/Finishes

Color tiles intended for reference only.

| Color | Code | Description |
|--|------|--------------|
|  | 0 | White |
|  | FF | Sea Salt™ |
|  | 96 | Biscuit |
|  | 47 | Almond |
|  | FD | Cane Sugar™ |
|  | 95 | Ice™ Grey |
|  | G9 | Sandbar |
|  | K4 | Cashmere |
|  | 20 | Suede |
|  | KA | Black 'n Tan |
|  | 7 | Black Black™ |

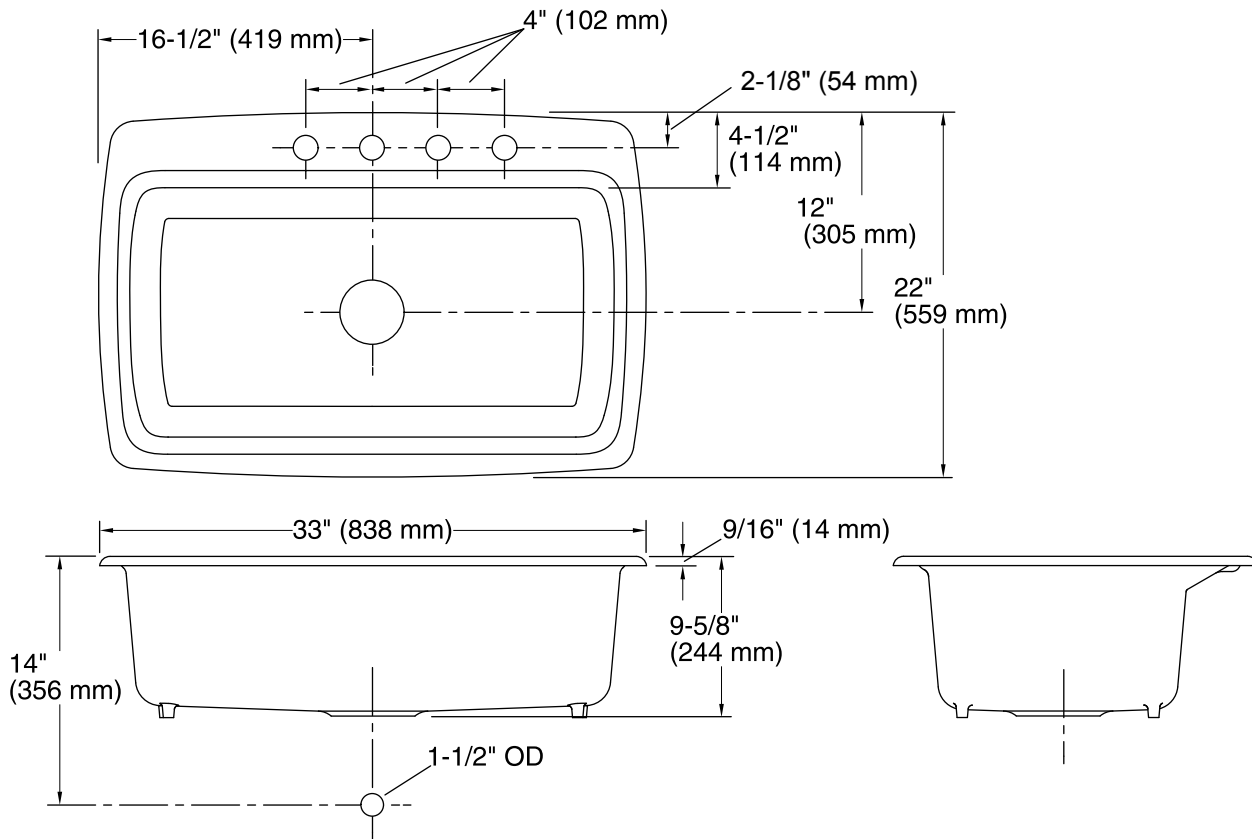

Technical Information

All product dimensions are nominal.

| | |
|-----------------------|---|
| Bowl configuration: | Single |
| Installation: | Top-mount |
| Cutout: | Top-mount, 30-1/2" x 20-1/8" (775 mm x 511 mm) with 1-1/2" (38 mm) radius corners |
| Bowl area | Length: 29" (737 mm) Width: 15" (381 mm) Bowl depth: 9" (229 mm) |
| Number of deck holes: | 4 |
| Faucet hole(s): | 1-3/8" (35 mm) |
| Drain hole: | 3-5/8" (92 mm) |

Notes

Install this product according to the installation guide.