



Features

- Center drain.
- Integral lumbar support and armrests for comfort.
- Textured bottom surface.
- 60" (1524 mm) x 60" (1524 mm) x 21" (533 mm)

Material

- Acrylic

Hydrotherapy

- Single-speed whirlpool offers six fully adjustable hydro-massage jets for water flow and direction.
- Pump with air switch for whirlpool.
- Multiple pump location options give you more choices for installation and access.
- Built-in 1500 W heater.

Installation

- Drop-in

Recommended Accessories

- K- 11677 Bath Drain
- K- 1491 Bath/Whirlpool Pillow
- K- 1601 Bath/Whirlpool Footstop
- K- 9696 Whirlpool 6-Jet Trim Kit



Codes/Standards



ASME A112.19.7/CSA B45.10
CSA B45.5/IAPMO Z124
ASTM E162
ASTM E662
UL 1795
Greenguard UL 2818 - Gold

KOHLER® One-Year Limited Warranty

See website for detailed warranty information.

Available Color/Finishes

Color tiles intended for reference only.

Color	Code	Description
	0	White
	96	Biscuit
	47	Almond

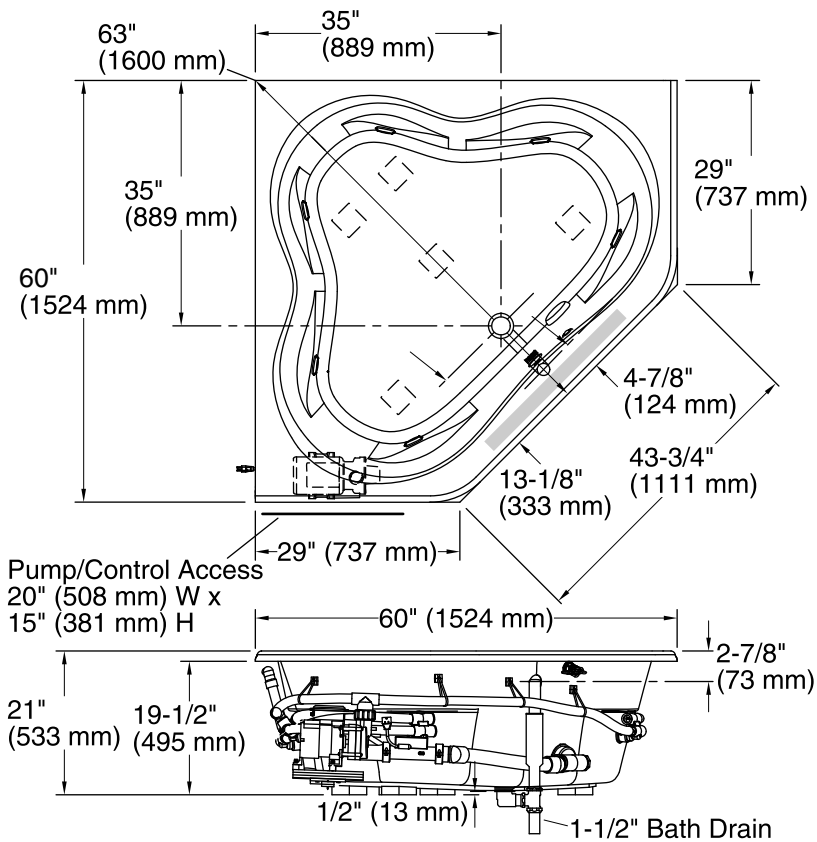

No change in measurements if connected with drain illustrated. (K-11677)

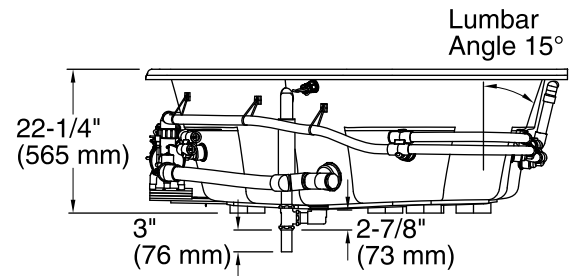
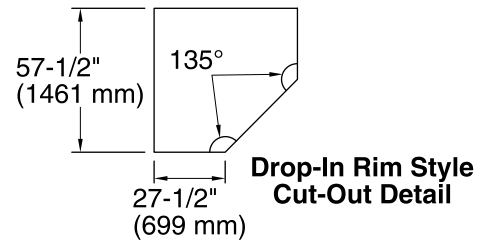
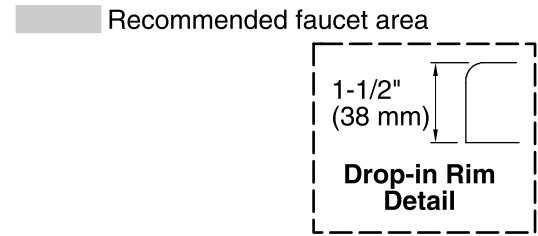

Required Electrical Service

Two dedicated circuits required, protected with Class A Ground-Fault Circuit-Interrupter (GFCI) or Residual Current Device (RCD).

Pump: 120 V, 15 A, 60 Hz
Heater: 120 V, 15 A, 60 Hz

Technical Information

All product dimensions are nominal.

Installation: Drop-in
Drain location: Center
Basin area, bottom: 52" x 38-3/4" (1321 mm x 984 mm)
Basin area, top: 61" x 46-1/4" (1549 mm x 1175 mm)
Weight: 131 lbs (59.4 kg)
Minimum floor load: 39 lbs/ft² (190.4 kg/m²)
Water depth: 15" (381 mm)
Water capacity: 96 gal (363.4 L)
Electrical component rating: Pump: 120 V, 7.5 A, 60 Hz
Heater: 120 V, 12.5 A, 60 Hz, 1500 W
Pump speed: Single

Notes

Measure your actual product for rough-in details.

Install this product according to the installation instructions.

The hot water supply should be 70% of the capacity of the bath or greater. Installations will vary.

Provide one grounded electrical outlet within 24" (610 mm) of each component.